

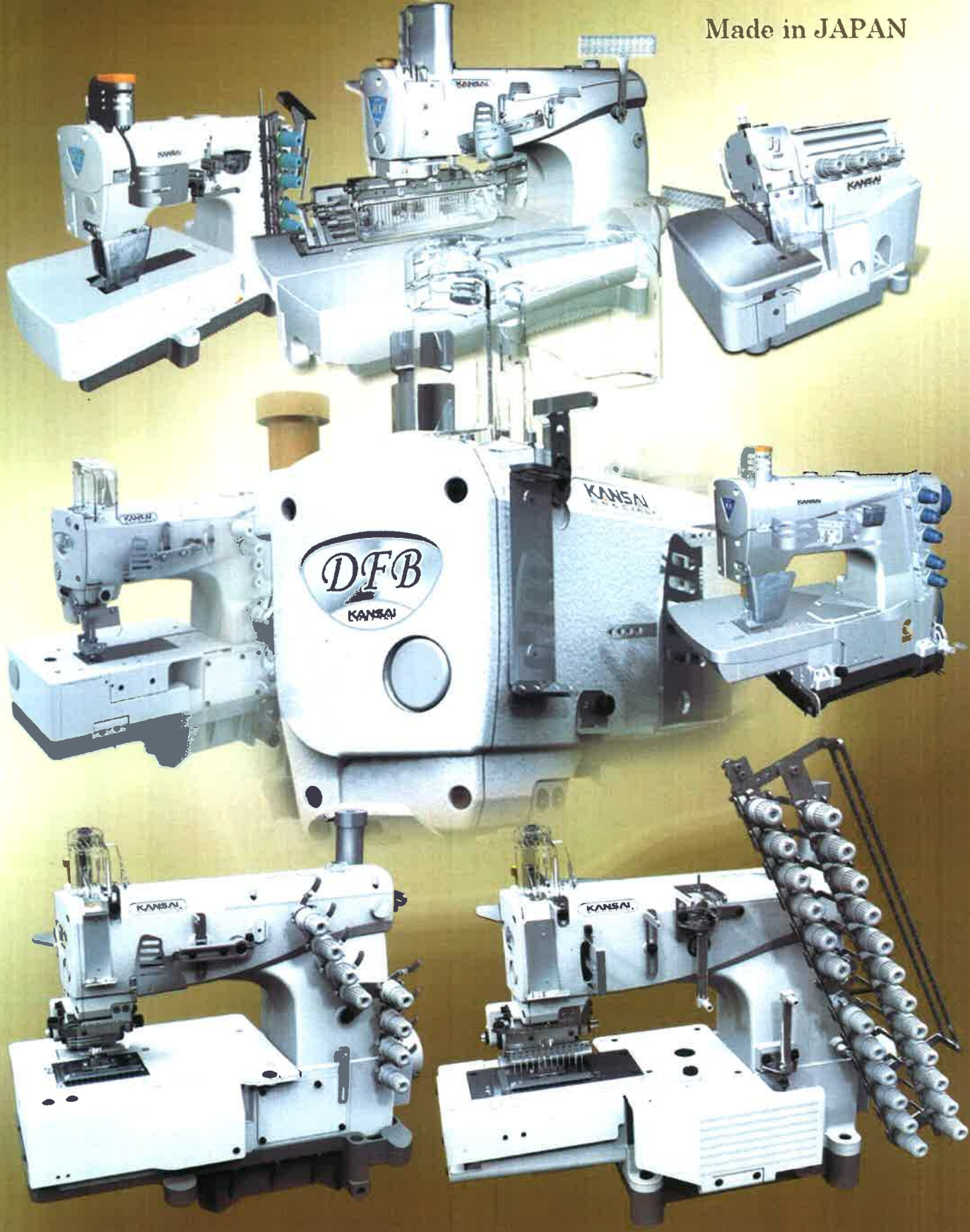

N-series/G-grade

Debut!

Made in JAPAN



“OIL PROTECTION” LINE UP

Equipped with the latest oil protection system with newly shaped arm design

Our latest “OIL PROTECTION” method prevent the leakage of the oil from the needle bar and presser foot bar area, but giving adequate lubrication to the machine for the high speed operation and durability of the machine.

Thanks to this stable lubrication and high “OIL PROTECTION” effectiveness, the following machines protect your important sewn products against oil stains and increase productivity.

“N”-series

- NR-series ---- Cylinder bed, high speed, top & bottom cover stitch machine
- NW-series --- Flatbed , high speed, top & bottom cover stitch machine
- NC-series ---- Small cylinder bed, high speed, top & bottom cover stitch machine

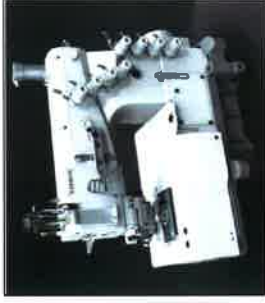
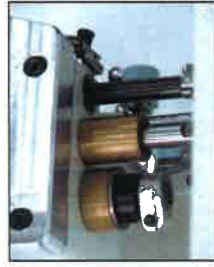

User friendly adjustment parts



4 thread overlock machine

JJ3014H-01M-2x4/DM

4 thread overlock machine for plain seaming from light to medium fabrics with Ho Hsing brand direct servo motor.



Compulsorily oil return from needle bar.

DLC coating needle bar

**HIGH SPEED
LOW NOISE
LOW VIBRATION
DESIGN**















Easy Differential feed adjustment

One touch Push button stitch length adjustment

Equipped with needle cooler and thread cooler and micro adjustment looper holder.

Direct drive servo motor increase productivity and save electricity cost



Model Name	Application	Material	No. of needles	No. of threads	Needle gauge (mm)	Over edge width (mm)	Stitch length (mm)	Feed dog type	Feed dog pitch (mm)	Diff.Feed ratio	Presser foot lift	Maximum Speed
JJ3014H-01M-2x4/DM	 Plain seaming	 light to medium	 2	 4	 2	 4	 1~3.8		 1.6	 0.7~2	 6	 7500

Morimoto Mfg. Co., Ltd.

180, Suna, Shijohnawate-City, Osaka 575-0001, Japan
Tel: (81)72-877-1221 Fax: (81)72-878-9649 URL: www.kansai-special.com



Picoting & fagoting machine

PX302G-4W

2 needle, Flat-bed, Double chain stitch,
4 point zigzag machine

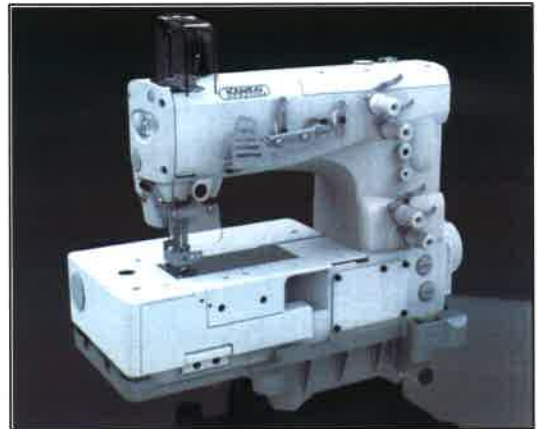

“G”-grade = New arm design with oil protection

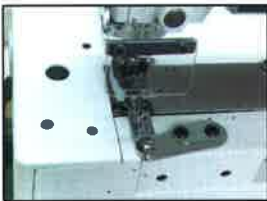

Stitch length adjustment by push button



Stylish new arm design





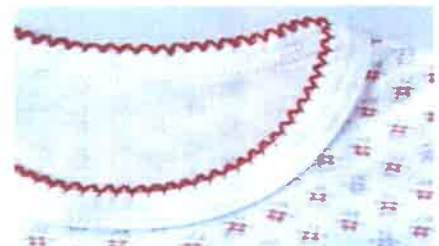



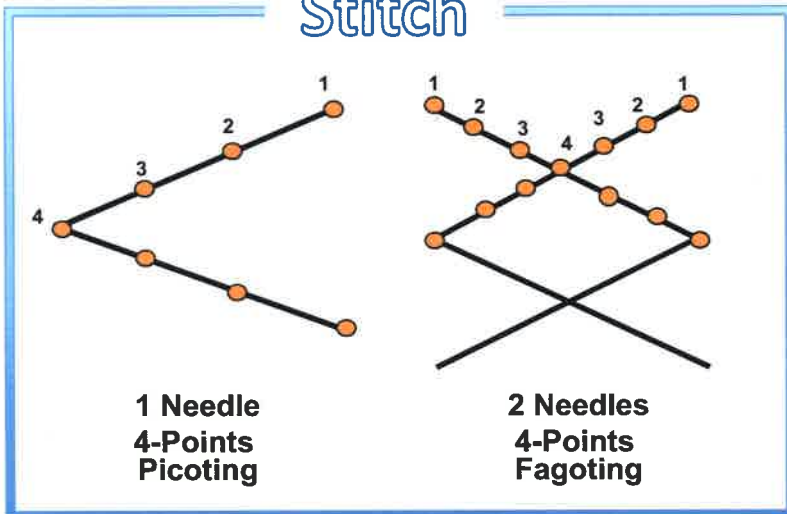



Closed window for Needle thread take up to avoid oil leak



Stitch



Model Name	Application	Material	Needle	No. of threads	Needle gauge	Needle bar stroke	Stitch length	Diff.Feed ratio	Presser foot lift	Maximum Speed
PX302G-4W	 Picoting and Fagoting	 Medium	 UO163 #11x2	 4	 2*5.55mm	 31mm	 0.9mm		 8mm	 3500



Flat bed top and bottom
covering machine

NW-8803D/DM

3 needle, flat-bed top and bottom cover stitch machine for multi purpose operation with Ho Hsing brand direct servo motor.



"N"-series = New arm design with oil protection

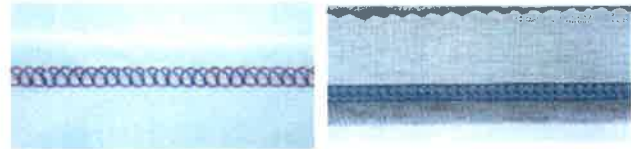

Oil seal in bush for needle bar and presser foot bar to stop oil leak

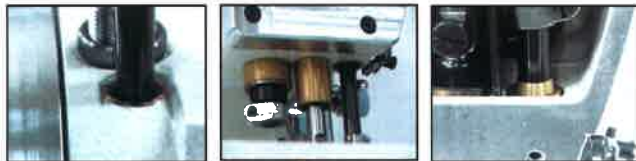

User friendly design



Micro adjustment presser foot



Convertible needle bar stroke 31mm ⇄ 33mm



Convertible front cover



Slide out type take up cam



Adjustable main feed dog position



Oil return device in feed dog shield cover



Micro adjustment looper holder



Direct drive servo motor increase productivity and save electricity cost

Model Name	Application	Material	Needle	No. of threads	Needle gauge	Needle bar stroke	Stitch length	Diff.Feed ratio	Presser foot lift	Maximum Speed
NW8803D/DM	Top & bottom covering	Light to medium	UY128GAS #9-14x3	5	7/32, 1/4	31mm	8-16 stitch/inch	0.7-2	6mm	6000

Morimoto Mfg. Co., Ltd.

180, Suna, Shijohnawate-City, Osaka 575-0001, Japan

Tel: (81)72-877-1221 Fax: (81)72-878-9649 URL: www.kansai-special.com

KANSAI SPECIAL



Made in Japan



Cylinder bed top and bottom covering machine

NR-9803CC/UTA/DM

3 needle, cylinder-bed top and bottom cover stitch machine for left fold covering, plain seaming with extra parts for center covering and hemming conversion sets with pneumatic thread trimmer and Ho Hsing brand direct servo motor.

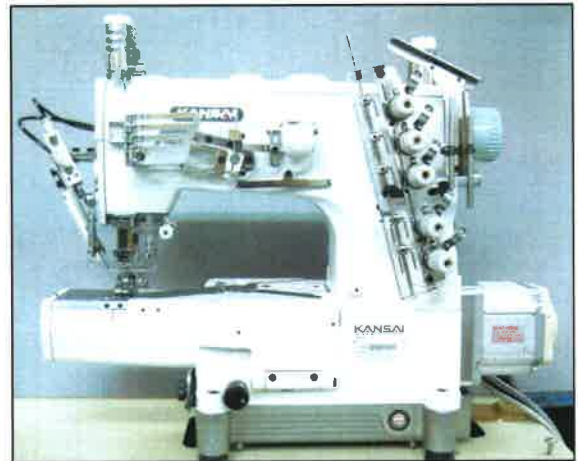

"N"-series = New arm design with oil protection



3 Operation in 1 Machine



Left Fold Covering

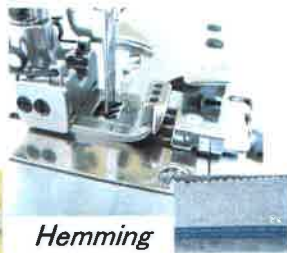

Hemming



Center Covering

COVERING MACHINES COMPARISON | comparación de las máquinas que cubre / 蓋縫機の相違

TYPE	NR9803C	NR9803CC	NR9803CLW
	STANDARD GAUGE	STANDARD GAUGE	STANDARD GAUGE
C TYPE	STANDARD	IN ACCESSORY BOX	IN ACCESSORY BOX
CL TYPE		STANDARD	STANDARD
A TYPE		IN ACCESSORY BOX	



UTA and direct drive servo motor increase productivity and save electricity cost

Model Name	Application	Material	Needle	No. of threads	Needle gauge	Needle bar stroke	Stitch length	Diff.Feed ratio	Presser foot lift	Maximum Speed
NR9803CC/UTA/DM	Top & bottom covering	Light to medium	UY128GAS #9-14x3	5	7/32, 1/4	31mm	8~16 stitch/inch	0.3-2.9	6mm	6000

Morimoto Mfg. Co., Ltd.

180, Suna, Shijohnawate-City, Osaka 575-0001, Japan

Tel: (81)72-877-1221 Fax: (81)72-878-9649 URL: www.kansai-special.com



Cylinder bed multi needle machine

FX4404GP/UTA/DM

4 needle, cylinder bed, double chain stitch machine with vertical looper movement mechanism with pneumatic thread trimmer and Ho Hsing brand direct servo motor.

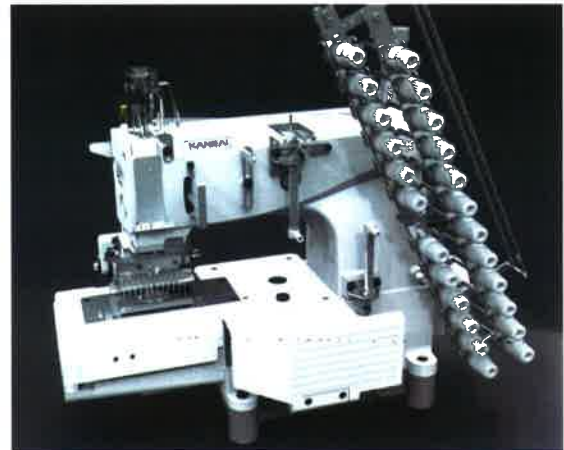

"G"-grade = New arm design with oil protection



Oil seal in bush for needle bar and presser foot bar to stop oil leak

New shape of lower needle bar bush to stop oil leak

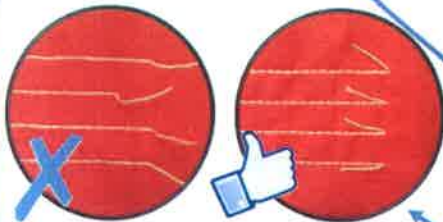

New technology:
Thread keeper mechanism can avoid skip stitch in starting time



UTA and direct drive servo motor increase productivity and save electricity cost

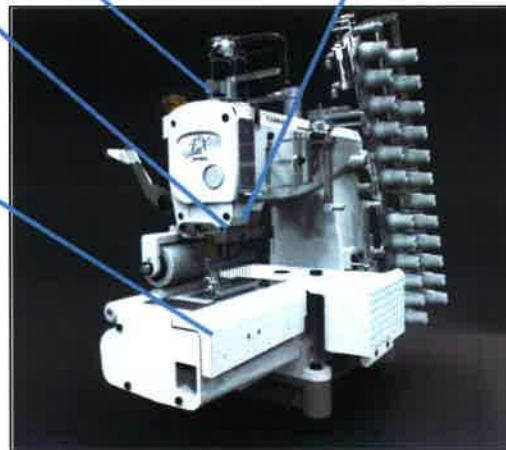

Best for attaching pre-closed elastic.
Circumference: 420mm



RT-1
Elastic expander device

Model Name	Application	Material	Needle	No. of threads	Needle gauge	Needle bar stroke	Stitch length	Diff.Feed ratio	Presser foot lift	Maximum Speed
FX4404GP/UTA/DM	Multi-Purpose	light to medium	DV57 #14x4	8	3/4, 1, 1-1/8, 1-1/4, 1-1/2	34.5mm	7~17 stitch/inch		8mm	4500 s.p.m



Multi needle machine

DFB1404GP

Flat-bed multi-needle double chain stitch machine for multi purpose.

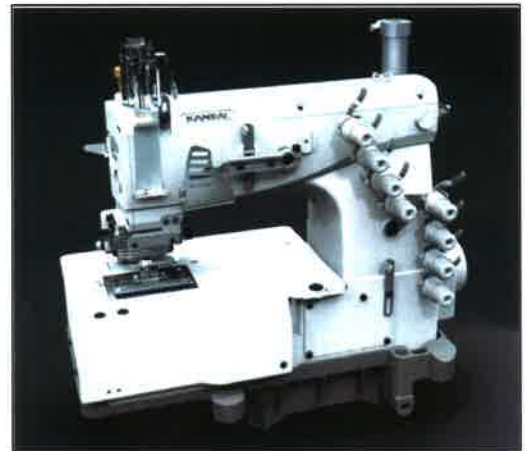

"G"-grade = New arm design with oil protection

Oil seal in bush for needle bar and presser foot bar to stop oil leak



Screw plug instead of rubber plug













New shape of lower needle bar bush to stop oil leak



Oil seal in bush for looper shaft



Model Name	Application	Material	Needle	No. of threads	Needle gauge	Needle bar stroke	Stitch length	Diff.Feed ratio	Presser foot lift	Maximum Speed
										
DFB1404GP	Multi-Purpose	Light to medium	UO113 #14x4	8	3/4, 1, 1-1/8, 1-1/4, 1-1/2, 1/4-1/2-1/4,	34mm	7-17 stitch/inch		8mm	4500

Morimoto Mfg. Co., Ltd.

180, Suna, Shijohnawate-City, Osaka 575-0001, Japan

Tel: (81)72-877-1221 Fax: (81)72-878-9649 URL: www.kansai-special.com

KANSAI
SPECIAL



Made in Japan



Small cylinder bed top and bottom covering machine

NC1103CL/UTA/DM

3 needle, cylinder-bed top and bottom covering stitch machine for left fold covering, plain seaming with extra parts for center covering conversion sets with pneumatic thread trimmer and Ho Hsing brand direct servo motor.

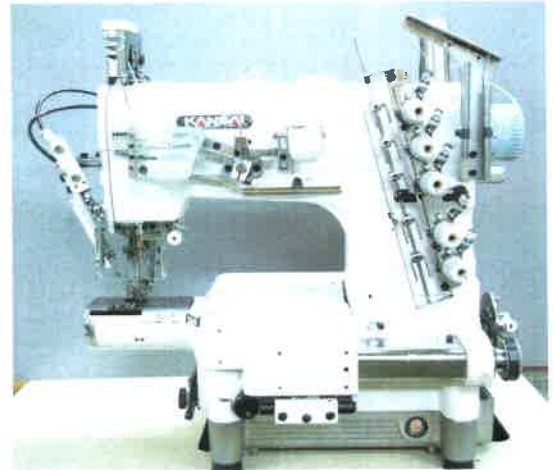

“N”-series = New arm design with oil protection



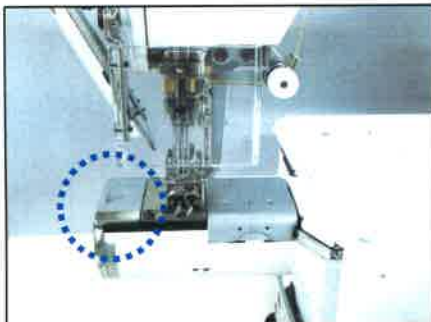

Circumference 180mm





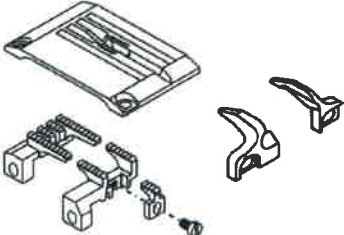

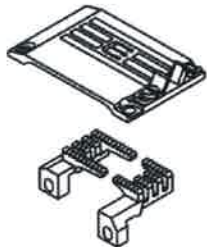

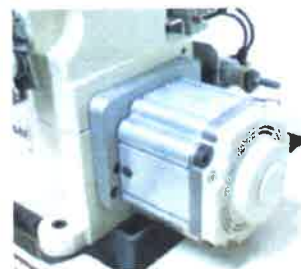



Easy threading & changing cam



TYPE	NC1103CL	
	STANDARD GAUGE	
		
C TYPE	STANDARD	
		
CL TYPE	IN ACCESSORY BOX	













UTA and direct drive servo motor increase productivity and save electricity cost

Model Name	Application	Material	Needle	No. of threads	Needle gauge	Needle bar stroke	Stitch length	Diff.Feed ratio	Presser foot lift	Maximum Speed
NC1103CL/UTA/DM	 Top & bottom covering	 Light to medium	 UY128GAS #9-14x3	 5	 7/32, 1/4	 33mm	 8-16 stitch/inch	 0.8-1.4	 6mm	 4500 sp.m

Morimoto Mfg. Co., Ltd.

180, Suna, Shijohnawate-City, Osaka 575-0001, Japan
Tel: (81)72-877-1221 Fax: (81)72-878-9649 URL: www.kansai-special.com

Model Name	Application	Material	Needle	No. of threads	Needle gauge	Needle bar stroke	Stitch length	Diff.Feed ratio	Presser foot lift	Maximum Speed
										
DFB1404GP	Multi-Purpose	light to medium	UO113 #14x4	8	3/4, 1, 1-1/8, 1-1/4, 1-1/2, 1/4-1/2-1/4,	34mm	7~17 stitch/inch		8mm	4500
FX4404GP/UTA/DM	Multi-Purpose	light to medium	DV57 #14x4	8	3/4, 1, 1-1/8, 1-1/4, 1-1/2	34.5mm	7~17 stitch/inch		8mm	4500
PX302G-4W	Picoting and Fagoting	Any material	UO163 #11x2	4	2*5.55mm	31mm	0.9mm		8mm	3500
NW8803D/DM	Top & Bottom covering	light to medium	UY128GAS #9-14x3	5	7/32, 1/4	31mm	8~16 stitch/inch	0.7-2	6mm	6000
NR9803CC/UTA/DM	Top & Bottom covering	light to medium	UY128GAS #9-14x3	5	7/32, 1/4	31mm	8~16 stitch/inch	0.3-2.9	6mm	6000
NC1103CL/UTA/DM	Top & Bottom covering	light to medium	UY128GAS #9-14x3	5	7/32, 1/4	33mm	8~16 stitch/inch	0.8-1.4	6mm	4500
NB1433PQSM	Shirring & smocking	Light	DVx57#14	132	3/16	34	4-18 stitch/inch		6mm	2000
JJ3014H-01M-2x4/DM	Plain seaming	light to medium	2	4	2mm		1~3.8mm	0.7-2	6mm	7500

Morimoto Mfg. Co., Ltd.

180, Suna, Shijohnawate-City, Osaka 575-0001, Japan

Tel: (81)72-877-1221 Fax: (81)72-878-9649 URL: www.kansai-special.com